

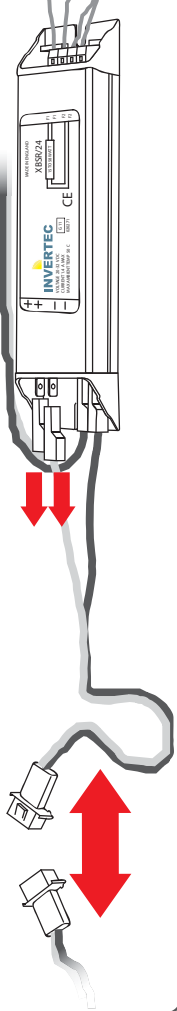

Retro-Fit LED T8 Tube Conversion Kit for XBSR/24

1  **Disconnect all power to the inverter!**
Before removing leads from inverter.

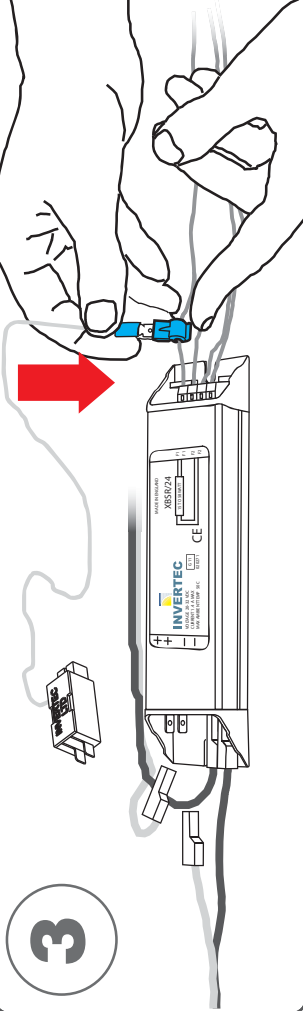

Remove positive cables from inverter input side

3 

Connect link lead into T-TAP

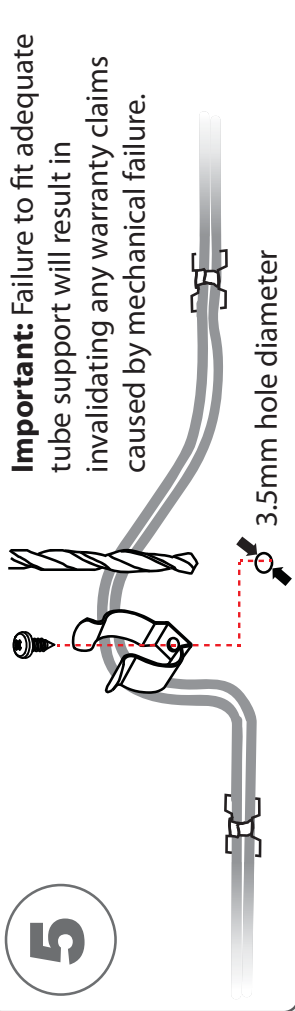
5 

Important: Failure to fit adequate tube support will result in invalidating any warranty claims caused by mechanical failure.

3.5mm hole diameter

For additional support use tube clip kit provided and move cable if applicable

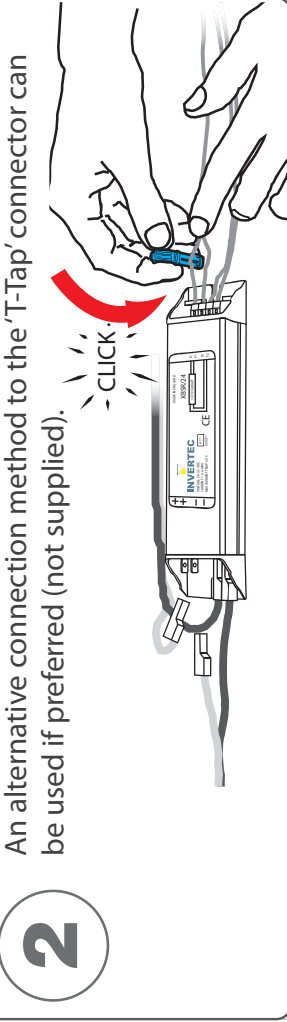
2 

An alternative connection method to the 'T-Tap' connector can be used if preferred (not supplied).

Attach cable T-TAP connector to the F1 tube connection

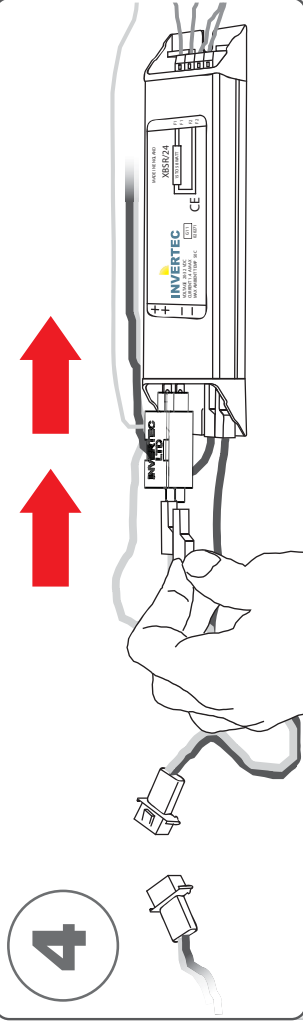
4 

Push link lead box onto positive terminals
Push positive cables onto link lead box

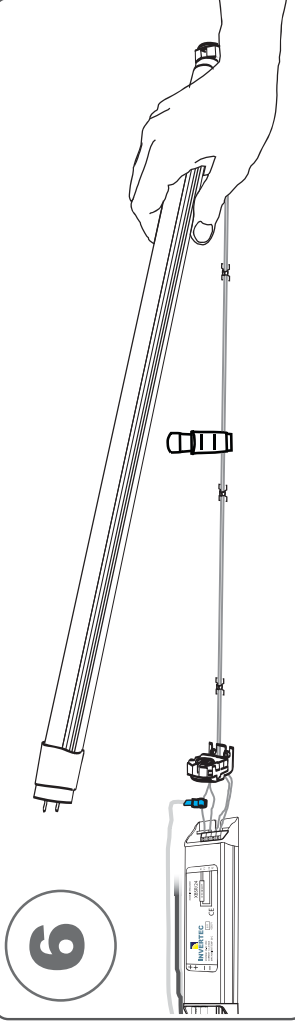
6 

Remove fluorescent tube and replace with LED tube
Check wiring and tidy cables and reconnect power